

American Fencing

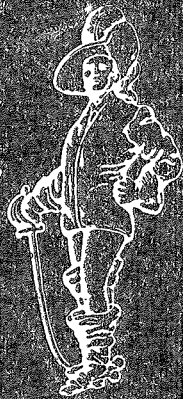

Volume 17

Number 1



ROBERT RUSSELL
U.S. Foil Champion, 1965

Official Publication of the Amateur Fencers League of America

NOVEMBER, 1965

AMERICAN FENCING

Official Organ of the Amateur Fencers League of America

Management

W. L. Osborn, Publisher

J. R. de Capriles, Editor

P.O. Box 144

41 Fish Hawk Drive, Oak Hill,

Terre Haute, Ind.

Middletown, New Jersey 201-671-5872

Feature Editors: Miguel de Capriles, Claribel Saunders and Ralph Goldstein.

Advertising Office: 5 Great Oak Lanem, Pleasantville, N.Y.

Telephone: 867-9191

Policy Board

N. Lewis, Chairman; J. R. de Capriles, W. J. Latzko,

W. L. Osborn, L. Sobel, G. V. Worth

Subscriptions for non-members of the AFLA is \$3.00 in the U.S. and \$4.00 elsewhere.

Published November, January, March, May, July and September.

Opinions expressed in signed articles reflect the personal views of the writers and not necessarily of American Fencing or the AFLA. No anonymous articles accepted.

Entered as Second Class Matter at the Post Office in Terre Haute, Ind.

DEADLINE FOR 1966 ISSUES

January — Dec. 12

May — April 12

September — Aug. 12

March — Feb. 12

July — June 12

November — Oct. 12

NEW ADDRESS

All copy for American Fencing should be sent to the editor at his new home - 41 Fish Hawk Drive, Oak Hill, Middletown, New Jersey.

Canada

The annual tournament at the Canadian National Exposition in Ontario was held on September 4 and 5. The U.S. won all the team events. The women (O'Connor, Reid, Jantelli, Sokol) won 9/7; the foilsmen Checkes, Farrell, Spinella) won 6/3; the epeemen (Checkes, Farrell, Morales, Spinella) won 10/6; and the sabremen (Checkes, Gall, Morales) won 7/2.

G. V. Worth

Personals

George Siebert of the Cavaliers died October 12. He was one of Southern California's outstanding fencers, having won the division's open championships in foil and epee. Our condolences to his wife Ellen and son Tommy.

NOMINATING COMMITTEE

The following were elected at the Annual Meeting to serve on the National Nominating Committee to select the slate of officers for the 1966-67 season pursuant to Article XI, Section 3 of the By-Laws and page xv of the Manual:

John Farrell, Metropolitan, Chairman; Jack Baird, Southwest; Mannie Forrest, Southeast; John Geraci, North Atlantic;; Harriet King, Pacific Coast; Jacques de Lannoy, Midwest.

FENCER HEADS ARGENTINE OLYMPIC COMMITTEE

Dr. Ricardo Levene, President of the Argentine Fencing Federation and Chairman of the Organizing Committee for the 1962 World Fencing Championships, has been elected President of the Argentine Olympic Committee, which is also the Argentine Sports Federation, the governing body of all Argentine sports.

Dr. Levene, a lawyer and former judge, was a member of the Directoire Technique at the Olympic Games of 1960 and 1964.

FROM THE PRESIDENT

Through the IBM cards maintained by Columbia Record Club, which handles our mailings to members at no cost to the League, your President has been furnished with a listing of all members of the AFLA during the past six years. An impressive compilation.

The listing also indicated which individuals were members for the 1964-65 season. This was **not** an impressive compilation. It was disappointing and disheartening to scan page after page and recognize name after name - people who had a known interest in fencing - not current members. How to combat this!

Your National officers want to develop a program which will be successful in increasing AFLA membership. It has become evident that the drive for additional members must originate at the division level. It is the responsibility of the National office to provide divisional personnel with adequate material to supplement the membership drive. The AFLA Publicity Committee, under the able direction of John Geraci, is developing a brochure entitled "The AFLA and You". It will be available soon for distribution to all divisions and is designed to explain the reasons for joining the AFLA, etc. We believe it will be an impressive "sales" aid. Divisional chairmen and Executive Committees must

assume the responsibility to insure the widest distribution of the brochure at all fencing levels.

A prime source of potential members exists in each Division's files. Former members should be contacted by mail, phone and in person to rejoin and solicit members. Specific individuals should be designated to perform this task. The task should be planned and organized in an efficient manner; work-load should be distributed. Test drives in a few locales have produced encouraging results.

Another very fertile source of AFLA members is the college fencing alumni. Some have continued fencing after college - more have not. Preliminary test surveys indicate that if several college alumni undertook the task of soliciting AFLA membership from their college contemporaries, the results would be inspiring. Each division should itemize the colleges located within its boundaries and designate specific individuals for the task. Do not select well-intentioned personnel - select those willing to help by **working**. Results can be achieved. It can be done!

We welcome any suggestions or criticism regarding the effort to increase AFLA membership. Please help!

Norman Lewis,
President, AFLA Inc.

No. Texas

by Rev. Jared Foster

Epee Open: 1. Edwin Sims, Dallas Y; 2. H. Edward Stone, Dallas Y; 3. William Towry, Dallas Y.

Women's Open: 1. Helen Livingston, Dallas Y; 2. Helen Orr, Ft. Worth; 3. Helen Reynolds, Dallas Y.

Foil Open: 1. Robert Russell, Dallas Y; 2. Edwin Sims, Dallas Y; 3. William Towry, Dallas Y.

Women's Novice: 1. Patricia Nevo, Dallas Y; 2. Kathie Foster, Dallas Y; 3. Betty Landy, Ft. Worth.

Women's Open: 1. Helen Livingston, Dallas Y; 2. Marietta Towry, Dallas Y; 3. Kathie Foster, Dallas Y.

Sabre Novice: 1. James Orr, Ft. Worth; 2. Angelo Micocci, Ft. Worth; 3. T. E. Brents, Ft. Worth.

Sabre Open: 1. Axel Tan, Dallas SC; 2. William Towry, Dallas Y; 3. James Orr, Ft. Worth.

Arizona

by Ben Vigil

Foil: 1. Art Olson, TFG; 2. Leonard Aron, Unatt; 3. Lyle Lamont, P.x.

Epee: 1. Art Olson, TFG; 2. Leonard Aron, Unatt; 3. Ross McKinley, TFG.

Sabre: 1. Ben Vigil, TFG; 2. Art Olson, TFG; 3. Rolf Kerker, Phx.

Foil: 1. Art Olson, TFG; 2. Ben Vigil, TFG; 3. Ross McKinley, TFG

Epee: 1. Art Olson, TFG; 2. Dave Classon, TFG; 3. Ben Vigil, TFG

Sabre: 1. Dave Snell, TFG; 2. Ben Vigil, TFG; 3. Mike Galway, P.x.

So. California

by P. A. Etter

Women's Prep: 1. Susan Joeck, LAFC; 2. Loraine Barak, LAFC; 3. Marge Morford, LAFC.

Foil Prep: 1. Robert Renger, Jerome; 2. Dave Morford, LAFC; 3. Mike Lehrer, LAFC.

Fo ilUnclass: 1. Phil Otto, Vince; 2. Lou Goldberg, LAFC; 3. Dan McCammon, HHS.

AFLA COMMITTEES, 1965-66

*Denotes Chairman, who has the right to appoint additional members.

Executive

Norman Lewis, President of AFLA*
 Nelson Fishman, VP, No. Atlantic
 Harold Goldsmith, Metropolitan Chairman
 William Latzko, Secretary of AFLA
 Leo Sobel, Treasurer of AFLA
 Evelyn Terhune, New Jersey
 George Worth, Foreign Secretary, AFLA

Constitutional

Alan Ruben, Philadelphia*
 Robert Blum, Metropolitan
 John Farrell, Metropolitan

Rules

Steve Sobel, New Jersey*
 Jose de Capriles, Non Divisional
 Paul Etter, So. California
 Richard Oles, Maryland
 Ed Zeisig, Wisconsin

TAKES ONE TO KNOW ONE!

This was once considered a pretty snappy answer to anyone who called you a name but there's some truth in it.

Because we are professional coaches and because we've been producing equipment for fencers for over half a century, we know, so well, the needs of the competitor and the limits required of the equipment.

Our weapons and equipment are designed to meet the specific needs of ALL fencers at ALL levels of participation.

Send for free catalog AF2



Electrical

Louise Neill, Metropolitan*
 Joseph Byrnes, New Jersey
 Manny Forrest, Gold Coast, Fla.
 Vince Pauley, Metropolitan

Certificate of Merit

Bill Towry, No. Texas*
 William Goering, Michigan
 E. S. Humphreys, Georgia

Reinstatement

Burton Moore, Connecticut*
 Ted Hootman, Kansas
 Mike Morgan, Philadelphia
 Art Olson, Arizona

Public Relations

A. John Geraci, New Jersey*
 Gerald Biagini, No. California
 Carl Borack, So. California
 Harry Chang,
 Paul Etter, So. California
 Walt Gaylor, New Jersey
 Richard Gradkowski, Metropolitan
 Harriet King, No. California
 Dave Logan, Kansas
 Art Olson, Arizona
 Joseph Sonnenreich, Metropolitan

A.A.U. Delegate

George Worth, Metropolitan*
 Gen. J. V. Grombach, Metropolitan

Modern Pentathlon Delegate

Gen. J. V. Grombach, Metropolitan*

National Championship Organizing

Harold Goldsmith, Metropolitan*

Transportation

Roland Asselin, Metropolitan*

Auditing

Peter Tishman, New Jersey*

U. S. Directors

Ralph Goldstein, Non Divisional*
 Jack Baker, No. California
 Art Olson, Arizona
 Laszlo Pongo, Long Island
 Anthony Zombolas, Illinois

Membership

Anthony Keane, New Jersey*

International

Ralph Goldstein, Non Divisional*
 George Worth, Secretary, Metropolitan
 Denise O'Connor, New Jersey

(Continued on Page 6)



Hospitality spoken here.

It starts *before* you even board the jet. You'll notice something special about the girl who makes your TWA reservation. She's pleased you chose TWA... and she shows it. TWA hospitality follows you through the terminal, right to your seat. It shows up as attentive service, superb food,

first-run movies* on coast-to-coast and transatlantic flights. On TWA, hospitality goes a long way—across the U. S., across Europe and beyond—on flights to 88 cities across half the world. A good thing to know when you start to plan your next trip. Make it soon.



*Complimentary in First Class, Coach and Economy, optional at \$1 in Transatlantic Economy. An Inflight Motion Pictures presentation.

AMENDMENTS TO BY LAWS.

Please make the following changes in your Rules Book, as approved at the Annual Meeting:

Article IV, Sec. 1 - 10th paragraph, starting at bottom of p. 218:

"All Active Collegiate and Student Members shall be entitled to participate in any competition held under the auspices of the Corporation, subject to such regulations and limitations as the Board of Directors may from time to time lay down with respect to particular categories or classes of members. Except in the case of new members admitted to membership on or after February 1st of each fiscal year, who shall have neither voting rights nor the right to hold office during that year, all Members shall be entitled to vote on all matters that may be voted upon by the Corporation pursuant to these By Laws and, if of legal age, to hold any office to which they may be elected or appointed. The date of admission to membership is determined as indicated in Article V."

Article IV, Sec. 2 - add to first paragraph: "or who has been reinstated as an amateur by the Board of Directors."

Article V, Sec. 1 (f) and 1 (g) - Change the word "Corporation" in the first sentence to read Amateur Fencers League of America."

Article V, - Renumber "Section 2" to "Section 3" and insert a new "Section 2". For all national matters including voting, participation in regional, national or international events, receipt of official notices, etc., a new member is not admitted to membership and an old member is not in good standing until the national portion of his dues has been received by the Secretary of the Corporation. However, for purposes of divisional activity, such as participation in local fencing events (including the qualifying round for the nationals or for regional tournaments), a new member is admitted to membership and an old member is in good standing on payment of his full dues (and initiation fee if applicable) to an authorized representative of the division (or in the case of non-divisional members, to the Secretary of the Corporation)."

Article VII, Sec. 1 (a) - add "Life Associate Members" before the words "Life Members".

Article XI, Sec. 3 - change date in the second paragraph from "March 1st" to "April 1st".

Article XI, Sec. 5, first paragraph - insert before the last sentence "Where three or more nominations have been duly filed for any office, the ballots shall be prepared and counted in accordance with a system for preferential voting approved by the Board of Directors."

Article XI, Sec. 6 - change to read:

"The officers and directors of the Corporation shall be elected by a majority of the votes cast and shall take office as of September 1 next ensuing and shall hold office until the following August 31 or until their successors are elected and qualified."

Article XI, Sec. 8 - change to read:

"Vacancies in the offices of President, Sectional Vice-President, Secretary, Treasurer, Foreign Secretary, Directors at Large, or Non-Divisional Directors, occurring between Annual Meetings shall be filled for the unexpired term by the Board of Directors."

Article XIII, Sec. 1 - add "Life Associate" after the word "Life" at the end of the first paragraph.

FLA COMMITTEES, 1965-66

(Continued from Page 4)

Anthony Orsi, New Jersey

plus the AFLA designees to the Olympic Fencing Games Committee, to be announced later.

National Ranking

Ed Zeisig, Wisconsin*

Nelson Fishman, Maryland

Ralph Goldstein, Non Divisional

Fred Linkmeyer, So. California

Anthony Orsi, New Jersey

New England Intercollegiate

by Lillian Aylward

The fourth annual New England Women's Intercollegiate Fencing Tournament was held at Brandeis University in Waltham, Mass. and attracted 70 participants from 15 colleges. Four individual events separate contestants on the basis of experience, and results were:

Beginner I (less than one semester)

1. Sylvia Cox, Radcliffe
2. Ellen Novak, Brandeis
3. Joy Copenhaver, Colby J.C.

Beginner II (1-2 semesters)

1. Diana Bishop, Radcliffe
2. Sandra Zacchini, Sargent
3. Sandra Astuti, Boston College

Intermediate (2-4 semesters)

1. Lynn Selker, Radcliffe
2. Judy Grinnell, Rhode Island College
3. Nancy Senecal, Westbrook, J.C.

Advanced (more than 4 semesters)

1. Laurie Maxon, Connecticut College
2. Sue Sherkow, Brandeis
3. Sue Billings, Radcliffe

The team standings were: 1. Radcliffe, 2. Brandeis, 3. Connecticut College. Other colleges (alphabetically) were: Boston, Bradford J.C., Colby J.C., Danbury State, Jackson, MIT, Rhode Island, Sargent, U. of Rhode Island, U. of Vermont, Wellesley and Westbrook J.C.

INSTITUTE ON GIRLS' SPORTS

by James G. Totten

The second National Institute on Girls' Sports at Michigan State University's Kellogg Center for Continuing Education will explore the sociological implications of sports for women, review research in growth and development, and increase understanding of some of the sports in which women participate.

Men and women with special interests in diving, fencing, gymnastics and track and field have been invited from each of the 50 states. About 300 are expected.

Dr. Thelma Bishop, institute directress, says the purpose of the institute is to increase the depth of experiences and expand opportunities for girls and women in sports. The emphasis will be on teaching techniques and

PORTRAIT OF A FENCER

by Gilbert Aloysius

(Ed. Note: A tribute to one who is helping to promote fencing in Western New York)

His name is Geza Pokay. Born and educated in Hungary, he has attained an outstanding scholastic record and has a degree of Ph.D. from the Francisco Josephina University in Szeged, Hungary. In the post war years he was a prominent attorney and became an administrator of court justice. When the struggle of the Hungarian revolt of 1956 proved futile, Dr. Pokay sought sanctuary in the United States and settled down in Buffalo.

The language barrier made it difficult to utilize his professional talents. However, in addition to his scholastic achievements, Dr. Pokay is very talented in the art of fencing. He teaches a group of enthusiasts known as the Buffalo Fencers Club. To each of these he imparts his knowledge to create ardent fencers.

Through the years Dr. Pokay has demonstrated his ability as a fencing master, has exhibited the finest qualities of a gentleman and has established a friendly relationship with all who have met him. We, his associates, friends and students are profoundly grateful for the assistance rendered us and look forward to many more enjoyable evenings with him.

on progression in these sports through active participation as well as discussion groups. Each person attending will be charged with the responsibility of helping teachers in her state to teach the sports when she returns.

Joining MSU in sponsoring the event are the Women's Board, U.S. Olympic Committee, and the Division for Girls' and Women's Sports, American Association for Health, Physical Education and Recreation.

The Fencing Committee consists of Yvonne Dempsy of State University College, New Paltz, N.Y. as Chairman; Ruth Lindsey, Oklahoma State University, and Charles Schmitter, MSU. The program includes lectures and demonstrations by the Committee members as well as by Julia Jones of Hunter College and Hugo Castello of NYU.

INTERNATIONAL DIRECTORS

The new list of FIE Directors has been issued. The numeral under each weapon denotes the classification. The highest rating, applicable for finals of World and Olympic Championships, is "3", with "2" being applicable for earlier rounds. Other Directors, proposed by their Federation, are given a "1" if they are assigned when available under observation of the Commission on Juries. The following is the list for U.S.A.:

Name	F	E	S
Anastasi	1	1	—
Asselin	2	2	2
Axelrod	2	2	1
Biagini	1	1	1
Blum	—	—	2
Bukantz	3	3	3
Campoli	1	1	1
Cohen	1	1	1
Dasaro	1	1	1
de Capriles	3	3	3
Dyer	1	1	1
Eisner	—	1	—
Farber	—	—	1

J. Farrell	—	1	—
J. Flynn	—	1	—
C. Gall	1	1	1
G. Glazer	1	1	—
W. Goering	—	—	1
H. Goldsmith	1	1	—
R. Goldstein	2	2	1
M. Grafton	1	1	—
J. Grombach	—	1	—
E. Hamori	1	1	1
J. Keane	1	1	1
A. Kemeny	—	—	1
A. Kerestes	1	—	2
H. Kolowrat	1	1	—
B. Krieger	1	1	1
W. Kunzig	—	1	1
F. Linkmeyer	—	1	—
D. Logan	—	1	—
D. Magay	1	1	1
P. Makler	1	1	1
J. Margolis	—	1	—
D. Micahnik	1	1	—
N. Muray	—	1	1
S. Muttbacher	—	1	—
T. Nyilas	3	3	3
T. Orley	1	1	1
C. Pallaghy	1	1	1
B. Pariser	1	1	1
L. Pongo	1	1	2
E. Richards	1	1	1
L. Silverman	1	1	—
H. Van Buskirk	1	1	1
D. Von Oppen	—	1	—
J. Wolf	1	1	1
G. Worth	3	1	3
A. Zombolas	1	1	—

Officials who have not demonstrated their ability in a major international event within the past four years are dropped from the "3" and "2" lists.



AMERICAN FENCING

Pentathlon National Championship

Paul Pesthy won the 1965 Modern Pentathlon Championship with an impressive record of 5,072 points, 65 more than runner-up Lt. Coots.

Pesthy has previously won the title in 1962, is the only civilian who competed for the U.S. on the 1964 Pentathlon Olympic Team, and was also a member of the 1964 Olympic Fencing Team.

On his way to the Pentathlon title he placed first in both the fencing and shooting events, fourth in riding, eighth in swimming and eleventh in running.

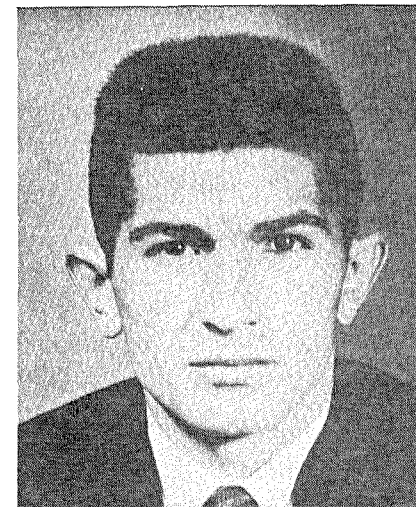

PAUL PESTHY



DIVISION CODE NUMBERS

In our last issue we published a membership report by division code numbers instead of names. The following numbers are coded on the IBM cards:

03 - Arizona; 04 - Border; 05 - Northern California; 06 - Southern California; 07 - Colorado; 08 - Columbus; 09 - Connecticut; 10 - Delaware; 11 - Florida; 12 - Central Florida; 13 - Gateway, Fla.; 14 - Gold Coast, Fla.; 15 - Georgia; 16 - Gulf Coast, Tex; 17 - Harrisburg; 18 - Hudson Berkshire; 19 - Illinois; 20 - Central Illinois; 21 - Indiana; 22 - Iowa; 23 - Kansas; 24 - Kentucky; 25 - Long Island; 26 - Maryland; 27 - Metropolitan; 28 - Miami Valley; 29 - Michigan; 30 - Minnesota; 31 - New England; 32 - New Jersey; 33 - New Mexico; 34 - (Inactive); 35 - Northern Ohio; 36 - S. W. Ohio; 37 - Oklahoma; 38 - Oregon; 39 - Philadelphia; 40 - Western Washington; 41 - St. Louis; 42 - (Inactive); 43 - North Dakota; 44 - North Texas; 45 - Washington, D.C.; 46 - Westchester; 47 - Western, N. Y.; 48 - Western, Pa.; 49 - West Virginia; 50 - Wisconsin; 51 - Non Divisional; 52 - West Point; 53 - North Carolina; 54 - mail service; 55 - Hawaii.

The code 01 is complimentary and 02 subscriptions.

AMERICAN FENCING

"POSITIVE ACTION"
with the New Balance
FENCING SHOE

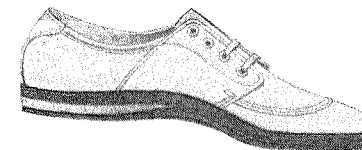

NEW BALANCE has designed a fencing shoe with many exclusive features that give you the fullest use of your abilities.

On the left shoe, the sole is brought up on the inside to protect the arch from chafing.

On the right shoe, the heel is curled back to permit easy "flow" of motion and to cushion and protect the heel from bruises and shock.

Order direct from factory. \$14.95 plus 75¢ postage. Group prices on request.

NEW BALANCE

ATHLETIC SHOE CO.

2402 MASSACHUSETTS AVE. CAMBRIDGE, MASS. 02144

Page Nine

CHAMPIONSHIP EQUIPMENT
by the
Maker of Champions
GEORGE SANTELLI, Inc.
412 Sixth Avenue
New York 11, New York

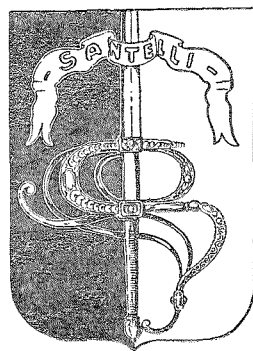

STATEMENT OF OWNERSHIP, MANAGEMNT AND CIRCULATION

(Act of October 23, 1962, Section 4369 Title 39, United States Code)

Date of Filing - September 28, 1965

Title of Publication - AMERICAN FENCING

Frequency of Issue - Bi-monthly

Location of Known Offices of Publication - P.O. Box 144, Terre Haute, Ind.

Location of Headquarters of General Business Offices of the Publisher - P.O. Box 144, Terre Haute, Ind.

Names and Address of Publisher, Editor and Managing Editor

Publisher W. L. Osborn, P.O. Box 144, Terre Haute, Ind.

Editor J. R. de Capriles, 41 Fish Hawk Drive, Middletown, N.J.

Managing Editor J. R. de Capriles, 41 Fish Hawk Drive, Middletown, N.J.

Owner. If owned by a corporation its name and address must be stated and also immediately thereunder the names and address of bondholders owning or holding 1 percent or more of total amount of stock. If not owned by a corporation, the names and addresses of the individual owners must be given. If owned by a partnership or other unincorporated firm, its name and address, as well as that of each individual member must be given.

Name	Address
W. L. Osborn	P.O. Box 144, Terre Haute, Ind.
J. R. de Capriles	41 Fish Hawk Drive, Middletown, N.J.

KNOWN BONDHOLDERS, MORTGAGEES, AND OTHER SECURITY HOLDERS OWNING OR HOLDING 1 PERCENT OR MORE OF TOTAL AMOUNT OF BONDS, MORTGAGES OR OTHER SECURITIES (if there are none, so state) — NONE.

Paragraph 7 and 8 include, in cases where the stockholder or security holder appears upon the books of the company as trustee or in any other fiduciary relation, the name of the person or corporation for whom such trustee is acting, also the statements in the two paragraphs show the affiant's full knowledge and belief as to the circumstances and conditions under which stockholders and security holders who do not appear upon the books of the company as trustees, hold stock and securities in a capacity other than that of a bona fide owner. Names and addresses of individuals who are stockholders of a corporation which itself is a stockholder or holder of bonds, mortgages or other securities of the publishing corporation have been included in paragraphs 7 and 8 when the interests of such individuals are equivalent to 1 percent or more of the total amount of the stock or securities of the publishing corporation.

THIS ITEM MUST BE COMPLETED FOR ALL PUBLICATIONS EXCEPT THOSE WHICH DO NOT CARRY ADVERTISING OTHER THAN THE PUBLISHER'S OWN AND WHICH ARE NAMED IN SECTIONS 132 231, 132 232, and 132 223 POSTAL MANUAL (Sections 4355a, 4355b, and 4356 of Title 39 (United States Code).

	AVERAGE NO. COPIES EACH ISSUE DURING PRECEDING 12 MONTHS	SINGLE ISSUE NEAREST TO FILING DATE
Total No. Copies Printed (Net Press Run)	3500	3500
Paid Circulation		
1. Sales through Dealers and Carriers, Street Vendors and Counter Sales	0	0
2. Mail Subscriptions	3000	3000
Total Paid Circulation	3000	3000
Free Distribution (including samples)		
By Mail Carrier Delivery or by other means	150	150
Total Distribution (sum of C & D)	3150	3150
Office use, Left Over, Unaccounted, Spoiled After Printing	350	350
Total (Sum of E & F - should equal net press run shown in A)	3500	3500

(Signature of Editor, publisher, business manager or owner)
 J. R. de Capriles, Editor
 /S/
 I certify that the statements made by me above are correct and complete.

NATIONAL RANKINGS FOR 1965-66

Women

1. Janice Romary, Vince
2. Carol Abby, NYU
3. Bonie Linkmeyer, So. Cal. FC
4. Evelyn Terhune, Terry's Tigers
5. Denise O'Connor, Santelli
6. Averil Genton, Metropolitan
7. Julie Moore, Selberg
(Anne Drungis, Santelli)
8. (Madeline Miyamoto, Terry's Tigers
(Vivienne Sokol, Fencers Club

Foil

1. Robert Russell, Santelli
2. Albert Axelrod, Fencers Club
3. Uriah Jones, Santelli
4. Anthony Zombolas, Chicago FC
5. Rudy Berger, LAFA
6. Marvin Grafton, Fencers Club
7. Joseph Checkes, Fencers Club
8. Frank Anger, Unattached
(Herb Cohen, Fencers Club
9. (Marty Davis, Csiszar
(Ralph Spinella, NYAC

Epee

1. Joseph Elliott, Nord
2. Gil Eisner, NYAC
3. David Micahnik, Csiszar
4. Joseph Checkes, Fencers Club
5. Mike Morgan, U of P
6. Paul Pesthy, NYAC
(Edward Carfagno, Harvard
7. (John Farrell, NYAC
(Ed Sims, Dallas Y FC

Sabre

1. Alex Orban, NYAC
2. Eugene Hamori, Csiszar
3. William Goering, Detroit FC
4. Thomas Balla, Csiszar
5. Laszlo Pongo, NYAC
6. Chaba Gall, NYAC
7. Paul Etter, Vince
8. Nelson Fishman, Wash. FC
(David Micahnik, Csiszar
9. (Henry Byer, Csiszar

WHAT'S NEW?

We'll tell you what's new if you'll send for our Fencing Equipment Newsletter. Published bi-monthly by American Fencers' Supply, this bulletin gives timely tips on maintenance and repair of standard and electrical fencing gear as well as information on new items of fencing equipment from AROUND THE WORLD.

While you're at it, ask for our new illustrated catalog.

Special discounts to professionals, schools and clubs.

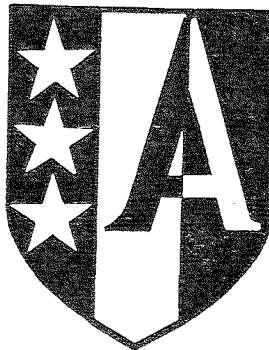

AMERICAN FENCERS' SUPPLY CO.

2122 FILLMORE STREET • SAN FRANCISCO, CALIF.

- * quality equipment
- * immediate delivery
- * competitive prices
- * personalized service

CHANGES AND ADDITIONS TO AFLA DIRECTORY

rector-At-Large: Jose R. de Capriles, 41 Fish Hawk Drive, Oak Hill, Middletown, N.J.

Calif. - Chairman - Paul Etter, 10660 Wilkins Ave., Los Angeles 90024

Add. Directors - Carl Borack, 204 S. Hamel Dr., Beverly Hills

Joe Elliott, 20033 Saticoy, Canoga Park

Fred Linkmeyer, 5105 Fulton Ave., Sherman Oaks

Carl Milletteire, 520 S. Hobart Blvd., Los Angeles 90005

Fred Rayser, 4325 Franklin Ave., Los Angeles 90027

Dave Rice, 1508 W. 12 St., Los Angeles 90015

Janice Romary, 4959 Dunman St., Woodland Hills

Colorado - Chairman - John Reubens, 405 Kalmia, Boulder 2

Illaware - Chairman - Earl Harbison, 106 Somer Ave., New Castle 19720

California Coast - Chairman - Robert Shelby, 540 Chelsea St., Bellaire, Tex.

Hawaii - Chairman - Hank Buermeyer, 1036 Jones St., Honolulu 96818

Michigan - Add. Directors - William Goering, 8636 Plainview Ave., Detroit

Richard Berry, 411 Ellen Ave., Royal Oak

Dakota - Chairman - John McMahon, Dakota Clinic, University Ave., Fargo

Ohio - Add. Director - Herb James, 24088 Fairlawn Dr., North Olmsted

Oregon - Chairman - Mrs. G. Starkweather, 3298 Lorain Lane S.E., Salem

Washington, D.C. - Chairman - Harry Schaff, 737 Butternut St., NW, Wash., D.C.

DIVISIONAL SECRETARIES

Arizona Eva Schuff, 4678 East 26 St., Tucson, Arizona

Border Larry Akin, 6443 Cheyenne Tr., El Paso, Texas

Northern Calif. Alice Partanen, 217 Chester Ave., San Francisco, Calif. 94132

Southern Calif. Mrs. Pat Etter, 10660 Wilkins Ave., Los Angeles, Calif. 90024

Colorado Hugh P. Gibbons, 375 So. 41st St., Boulder, Colorado

Columbus Charles Simonian, Ohio State U., 337 W. 17th Ave., Columbus, Ohio

Connecticut Alexander Bublick, 382 Burnside Ave., East Hartford, Conn. 06108

Delaware Roger U. Owings, 1511 Lakewood Dr., Northwood, Wilmington, Del.

Florida Mrs. Marge Augustine, 2148 Clematis Pl, Sarasota, Fla.

Central Florida Karen Meadows, 1705 Round Pond Ave., Tompa, Fla.

Gateway, Florida Mrs. Marjorie McHenry, 1719 Belmont Ave., Jacksonville, Fla. 32207

Gold Coast Loretta Kushner, 8460 S.W. 185th Terrace, Miami, Fla. 33157

Georgia William R. Arnold, 3664 Larkspur Terrace, Decatur, Georgia

Gulf Coast James Monk, 922 Howell, La Marque, Texas 77568

Harrisburg Jeanne Thompson, 240 N. Duke St., Lancaster, Pa.

Hudson-Berkshire Frank Collins, 98 Chestnut St., Albany, New York

Illinois Ella Hrabar, 4243 N. Hazel St., Chicago, Ill. 60613

Central Illinois John Tocks, 410 E. John, Champaign, Ill.

Indiana Elmer White, Culver Military Academy, Culver, Ind. 46511

Iowa Paul Rybski, Men of Honor Res., C. Clg., Mt. Vernon, Iowa 52314

Kansas Miss Lee Stark, 1144 W. 11th St., Lawrence, Kansas

Kentucky Mrs. H. Clayton Robinson, Jr., Paris Pike, Lexington, Ky.

Long Island Mrs. Selma Satran, 2 Adelpia Road, Hicksville, N.Y.

Maryland John Rousseau, 2916 Manns Ave., Baltimore, Md. 21234

Metropolitan John Farrell, 42-02 Kissena Blvd., Flushing, N.Y.

Miami Valley Louis Cox, 400 Earnshaw Drive, Dayton 9, Ohio

Michigan Jan Meyerson, c/o Detroit Fencers Club, 9420 Woodward, Detroit, Mich.

Minnesota Tom Tietze, 2857 Edgewood Ave., St. Louis Park, Minn.

New England Kathryn Fairbanks, 145 Aldrich St., Roslindale, Mass.

New Jersey Mrs. Mary Ellen Flynn, 142 Dewey Ave., Totowa, N.J.

North Carolina Vincent Faraone, 307 S. 7th St., Mebane, North Carolina 27302

Northern Ohio Mrs. Alexander Kovacs, 3625 Chelton Road, Shaker Hgts., Ohio 44120

S.W. Ohio Phyllis Castells, 5020 Colerain Ave., Cinn., Ohio 45223

Oklahoma Joan Hegers, 1810 E. 12th St., Tulsa, Oklahoma

Oregon Mrs. Lenore Klinik, 2648 S.W. Sherwood Drive., Portland, Ore.

Philadelphia Ann Thomas, 2804 Welsh Road, Philadelphia, Pa. 19126

St. Louis Mrs. Margo Hasson, 1140 Indian Trail Drive, Olivette, Missouri 63132

North Dakota Sheila Green, Moorhead State College, Moorhead, Minn.

North Texas Fr. Jared Foster, 6110 Orchid Lane, Dallas, Texas

Washington, D.C. Dr. David J. Herzig, 4905 Battery Lane, Bethesda, Md.

Westchester Mrs. Joan Intrator, 31 Western Drive, Ardsley, NY 10502

Western New York Theresa Pipitone, 30 Miller St., Rochester, N.Y.

Western Wash. Mrs. Harriet Brewster, 4710-20th N.E., Seattle, Wash.

West Virginia Mrs. Sue Edmonds, 1033 10th Ave., Huntington, W. Va.

Wisconsin Mrs. L. Schneller, 160-N 5116 Hickory Tree, Menomonee Falls, Wisc. 53051

Non Divisional Mrs. W. J. Latzko, 33-62nd St., West New York, NJ 07093

West Point Cadet Douglas Thornbloom, U.S. Military Academy, West Point, N.Y. 10996

age Twelve

AMERICAN FENCING

WARNING TO APOLIGISTS

by John V. Grombach

In the last issue of American Fencing (Vol. 16, No. 6, p. 19) Norman Lewis states with respect to our poor showing at the 1964 Olympic Games: "From personal experience it seems that the main reasons are lack of frequent exposure to top notch international competitions, scarcity of top caliber coaches consistently exposed to world fencing, lack of government financial support, lack of publicity to entice athletic youths to participate in fencing, etc."

The "etc." cannot be questioned except by the King of Siam who is dead. However, in Mr. Lewis' top fencing days and before, when we did much better in international competitions, it would be easy to prove by documentary evidence that (1) we had less frequent exposure to top notch international coaches consistently exposed to world fencing, (2) we had less top caliber coaches consistently exposed to world fencing, (3) we had no government financial support and God help us when we do, for we will then have a politically appointed Sports Commissioner and a government fencing super-

visor who may have been a manufacturer of fences. A Tammany appointed chairman of the N.Y. State Boxing Commission was a ladies' underwear manufacturer who was quoted as saying, when he accepted the job, "I don't know the difference between a right cross and a water bucket." Maybe the government Sports Commissioner may say "Nuts to fencing" as it is not a "body builder". (4) We did not have as much publicity as today, with TV of the Martini & Rossi International Meet, articles, news stories, the nationals moving around the country, etc.

As far as government contributions are concerned, I have been busy talking to people. I can assure you that thousands of U.S. citizens and hundreds of private American organizations will cease and desist from financial contributions or gratuitous service if the U.S. Government contributes the taxpayer's money to amateur sports, with the ultimate take-over of amateur sports by the State — If that day comes I will go out for yachting so I can be issued a boat and some grog instead of a couple of epees and a mask.

U.S. Sweeps Maccabiah Fencing

by Larry Bortstein

The American squad of eight fencers, including one girl, swept all seven gold medals offered in fencing at the Seventh World Maccabiah Games, August 23-31, in Tel Aviv, Israel. Philadelphians Marty Davis and David Micahnik took the individual foil and epee titles respectively, while New Yorkers Wally Farber and Carol Abby won in sabre and ladies' foil, respectively.

Farber was a repeat winner, having won the gold medal in 1961. This year, approximately 1,000 athletes from 29 nations took part in a 20-sport program.

The most saddening aspect of the competition was the failure of Albert Axelrod in the foil due to a severely painful elbow condition. Axelrod, barely able to move the sword, could do no better than fifth in the six-man foil field.

Joseph Elliott of Canoga Park, Calif., who won the national epee championship in early

summer failed to break into the medal column in Israel as an individual, but won two golds as a member of the winning team epee and team foil foursomes.

The summaries:

Individual foil: 1. Marty Davis; 2. David Micahnik; 3. Michael Price, Great Britain.

Team Foil: 1. US (Davis, Micahnik, Joe Elliott, Larry Silverman).

Individual epee: 1. David Micahnik; 2. Yves Dreyfus, France; 3. Max Dwinger, Netherlands.

Team epee: 1. US (Micahnik, Davis, Elliott, Nelson Fishman).

Individual sabre: 1. Walter Farber; 2. John Ardley, Canada; 3. David Van Gelder, Netherlands.

Team sabre: 1. US (Farber, Micahnik, Fishman, Silverman).

Ladies' foil: 1. Carol Abby; 2. Marie Meyer, Netherlands; 3. Hanna Itzkovitz, Israel.

AMERICAN FENCING

Page Thirteen

REPECHAGE CHART FOR 16 FENCERS*

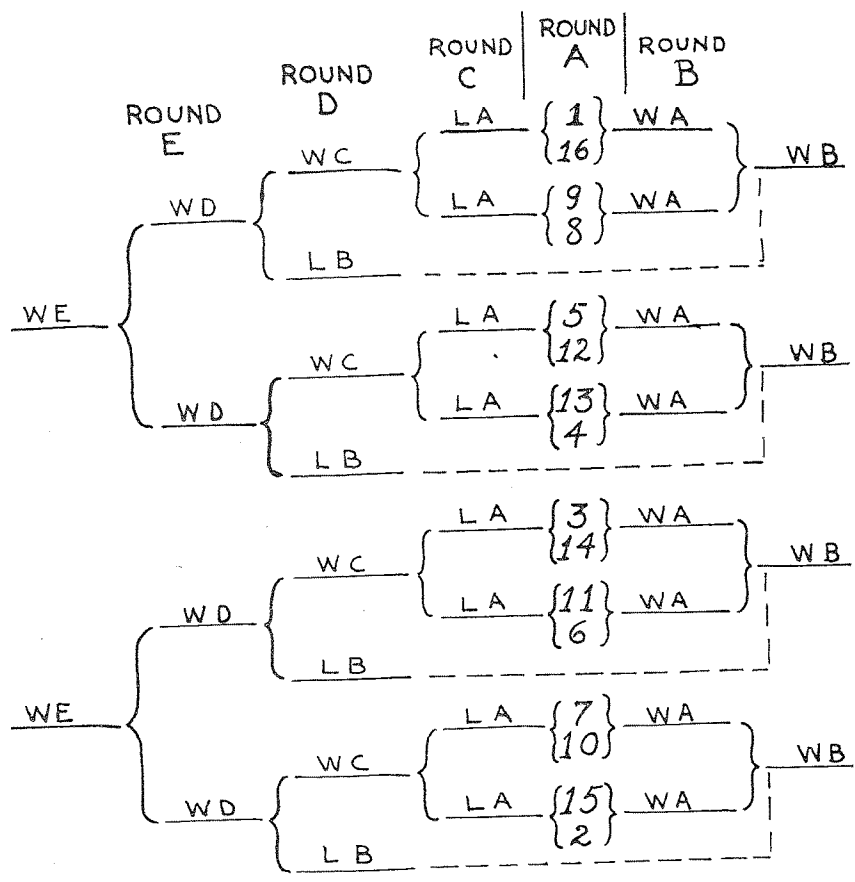

NOTE
 "WA"- Winner, Round A; "LA"- Loser, Round A; etc.
 This Chart for 16 fencers can be used for 32 by duplicating it for the lower half of the match plan and adding one round to the winners' and losers' brackets to obtain a final of six.

F I E RULES CHANGES

Ed. Note: These changes are not effective in the U.S. until they have been reviewed by the Rules Committee and adopted by the Board of Directors.

Rule 27 (5) Add: "In all weapons fencers' clothing must include a pair of white stockings which will cover fully any part of the legs not covered by the trousers."

Rule 31 change last sentence to read: "In the absence of a negative reply from either competitor he gives the signal . . ."

Rule 35 delete second paragraph and add: "When a fencer passes his opponent during a bout the President must immediately call 'Halt' and replace the competitors in the positions which they occupied before the movement which caused the fencer to pass his opponent occurred."

"When hits are made during the movement of a fencer passing his opponent, hits made during this movement are valid but a hit made by a fencer after he has actually passed his opponent must be annulled."

Rule 327 (h) change to read: "When a competitor against whom a hit has been registered has broken his blade the hit must be annulled." (It therefore is no longer necessary to join the wires of the broken blade to ascertain whether the epee was functioning.)

Major FIE Events

1. Individual event will precede team event in each weapon (as at present).
2. Team events will continue to consist of one round of pools followed by direct elimination.
3. Individual events will include at least two rounds of pools to qualify the desired number for direct elimination match plan. Qualification from pools will be by victories and, if necessary, count of touches. Fence-offs are used only if victories and touches are equal. For the direct elimination, fencers will be placed on the match plan according to indicators as at present (Rules 561) and will thereafter retain their placings. All matches in direct eliminations will be for two regulation bouts with a deciding bout if required (see Rules 555, 556). Direct elimination will pro-

ceed with repechage which will insure that no competitor is eliminated until he has lost twice. There will be a final pool of six fenced under normal rules except that if there is a tie for first place in number of victories, only one fence-off will be fought and if competitors are still tied, they will be placed according to the count of touches in the fence-off only.

New Method of Direct Elimination

Fencers who win their matches in the direct elimination stage continue normally until four unbeaten fencers remain qualified for the final round-robin of six. Fencers who suffer their first match defeat at any stage have the right of repechage by additional matches in direct elimination, always following the order of the match plan, until two fencers who will not have been beaten more than once remain qualified for the final of six. Any fencer who has lost twice in the direct elimination stage is eliminated. (See chart)

JOSEPH VINCE

former U.S. and Canadian Sabre Champion and Olympic Squad Coach announces the publication of his revised and substantially enlarged edition of **FENCING**, with foreword by the eminent author, Paul Gallico, and illustrated by Cornell Wilde, motion picture star.

Price \$3.75, including postage.

"Methodology of Sabre Fencing" by two noted Hungarian Masters (English translation) \$5.25 including postage.

"Fencing with the Electric Foil" by Crosnier. \$5.25 including postage.

JOSEPH VINCE
 FENCING EQUIPMENT COMPANY
 9416 Santa Monica Blvd.
 Beverly Hills, Calif.

THE FORGOTTEN CHAMPIONSHIPS

by Raymond W. Miller

Our record books go back only to 1892, the first National Championships held by the Amateur Fencers League of America. Championships had previously been conducted by the AAU but apparently those records were destroyed by fire in 1903. Considerable search finally brought fruit in the old New York Clipper and the New York Clipper Annual, a sporting newspaper with some files in the New York Public Library. I hope the statistics herein, such as they are, will find their place in the records next time they are published.

The first clue to the forgotten championships was the stated reason for the founding of the AFLA.

It was on April 23, 1891 that a group of prominent amateur fencers met at the New York AC to express their disapproval of the way fencing championships had been conducted by the AAU. They formed a committee to draft a constitution for a new organization and to prepare new rules, which we can suppose would reflect their dislike of the way things had been going.

By the 10th of June the twelve founders had signed up 89 other fencers and in 1892 the seceders from the AAU sponsored the National Championships for the first time. During the winter the League's president, Dr. Hammond, had conferred with representatives of the AAU who agreed to leave fencing matters to the Amateur Fencers League of America. Except for a brief skirmish in Pennsylvania in 1914, the AAU has acknowledged the AFLA as the ruling body for fencing in the U.S.

The truth is that the AAU itself had been organized only a few years before the fencers seceded and had conducted only four championships.

The first was held in New York on April 4 and 4th in 1888. W. S. Lawson won the foil, H. K. Bloodgood the sabre and Eugene Higgins the epee. All three represented the New York A.C.

The second championship was held in Jersey City on March 23, 1889 together with the boxing and wrestling championships. The previous year's winners did not defend their title but served as jurors, with H. K. Bloodgood as director. Two professionals, Regis Senac and Charles Koch, also served on the jury. B. F. O'Connor defeated Samuel Shaw in foil 5-2, Luis Francke defeated O'Connor 5-3 in sabre, and Dr. G. M. Hammond defeated O'Connor 5-3 in epee (No, epee was not always for one touch in the dear old days). All finalists were members of the New York A.C. and O'Connor and Francke also belonged to the Fencers Club.

The New York A.C. was the scene of the third championship on February 6, 7, 8, 1890. An unimpressed reporter noted "The entries were unprecedentedly numerous, but the great majority of the contestants were far more distinguished by reason of their lack of knowledge of the art than by their ability." Possibly he didn't wait to see the finals, for there was no question about ability there. Samuel Shaw of the NYAC defeated his teammate A. Gregor 5-4 in foil; George L. Heintz of the N.Y. Turnverein defeated Eugene Van Shaick of Manhattan AC 5-3 in sabre; and Van Shaick defeated Gregor 5-4 in epee. Perry Belmont headed the jury which included Higgins, Senac, Bloodgood, Koch and Armand Jacobi.

The fourth and final AAU championship was held March 7, 1891 but there is very little information on it. Certainly the seceders were not discontented losers, for Dr. Hammond the first AFLA president won both the foil and epee championship and Charles G. Bothner of the Pastime AC won the sabre.

The rules under which the four forgotten championships were fenced may provide some clue to the seceders' disapproval. Many of the 25 rules were not different in principle from the most modern. They called for a jury of 3 or 5 expert fencers, one of whom was the referee who gave the signal to begin. Touches were awarded by majority vote of the jurors who called touches in both directions. The competition was by direct elimination with

opponents drawn by lot, except that meetings of club mates were avoided as much as possible. All those defeated by the winner were eligible to compete for second place.

Rule 11 reads "The jury in deciding the bout can add one point to the losing contestant if they think his general form superior to that of his opponent, and should the score by addition of this point be made equal, they shall fence for three more points. The method of judging is based upon the idea that the contest is intended as an exhibition of skill rather than the mere securing of points."

The foil target was marked on the upper front half of the torso and a fencer forfeited one point by turning his back or by avoiding the point "either by a movement of arm or body".

The right of way is given to the attacker and "double touches, or cuts occasioned by both contestants lunging at the same time are considered bad form, and in case of a second offense one point shall be deducted from each contestant". The rules of right of way seem also to apply to epee and, according to Rule 18, "a second thrust while in the same lunge is not allowed".

The rules of the AFLA, adopted October 14, 1891, were not unlike those of the AAU for the most part. However, rule 4 provided that each contestant shall fence a bout with every other contestant. Each bout was to be for an aggregate of five touches, with each touch to count one point. "The judges", according to rule 6, "may award to each contestant in each bout a maximum of 50/100 of a point for defense, 50/100 of a point

for attack, and 50/100 of a point for general good form . . . The award shall be determined by the average of the points thus allowed by the judges. The contestant scoring the highest aggregate of points shall be declared the winner."

For twenty years the fencers regularly rewrote their rules, until 1912 when in their first overseas Olympic experience they finally determined that fencing was primarily a contest for points and not an exhibition of form. Strangely, whatever the rules, the victories usually came to the proven fencers of quality.

THE OFFICERS OF THE AFLA

and

THE STAFF OF AMERICAN FENCING

extend to you

Best Wishes

For The

Holiday Season

Manufacturer of A.F.L.A.
NATIONAL
CHAMPIONSHIP MEDALS
Since 1891

ROBERT STOLL
Incorporated

70 FULTON ST.
NEW YORK 7, N. Y.
Established 1885

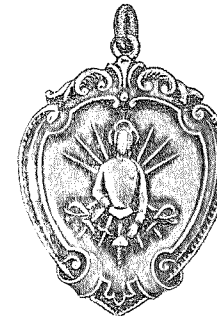

**Fencing Trophies
Medals Emblems**

DESIGNS,
CATALOGUES AND
ESTIMATES UPON
REQUEST

INTERNATIONAL WEEK IN MEXICO

by George V. Worth

Mexico sponsored a pre-Olympic Sports Week from October 11 to 18 and expects to repeat the invitation event in 1966 and 1967. There were eight nations represented in fencing: Cuba, France, Italy, Mexico, Rumania, Sweden, USA, and USSR.

The U.S. was represented by our four National Champions, Janice Romary, Robert Russell, Joseph Elliott and Alex Orban. Theriter had the honor of serving as Team Captain. The housing at Hotel Reforma, the food and transportation, were excellent. We had a car and driver at our disposal at all times and could not have been treated more courteously. The facilities for the competition were generally good and the events ran smoothly.

The caliber of the fencing was spotty. We watched three of the four finals but won no medals. Advance notice was too short for many of our fencers to train for this event, especially since it was held so early in the new season. It is hoped that we will have earlier notice for the next two Tournaments. The events resulted as follows:

Women's Foil

There were nine entries. Gorokhova (USSR) was undefeated. Pilar Roldan of Mexico placed second with 6/2 and Iencik of Rumania as third with 4/4. Jan Romary tied for fourth with 3/5 but dropped to seventh by 3 touches. She was not up to her usual game, due partly to her major operation in January and lack of training.

Foil

The field of 26 was reduced to a final of eight. Noel of France won with a 6/1 record, followed by Granieri of Italy (5/2) and Magnan of France (4/3). Bob Russell fenced well through the competition and reached the final, but lack of international experience put him

at a disadvantage against the more seasoned fencers. He placed eighth and was getting stronger as he went along.

Epee

The largest event (27 entries) was won by Kostava (USSR) with a 6/1 record in the final. France's Allemant and Italy's Granieri tied for second and placed as listed by a margin of one touch. Joe Elliott was undefeated in the first round and had a 3/4 record in the semi-final. It was not enough to place him in the final, but the strength of the pool is indicated by the fact that Magnan of France was also eliminated. Elliott was very strong until he suffered a double defeat and a 5-4 loss in succession. Considering his lack of experience in top-flight competition he fenced like a veteran and shows much promise.

Sabre

Melnikov of Russia won the event on a fence-off with La Regione of Italy. The winner took it 5-4 after leading 4-1. Cuba's Penabella placed third with 5/3. Alex Orban dropped to sixth on touches after tying for fourth with 4/4. He should have placed much higher, but lost heart after losing to three of the non-Mexicans. His fencing ranged from very good to very poor. In his defense I must say that the Jury (all Mexicans) was weak and this upset him a great deal even though I don't think he got any bad breaks.

Altitude no Factor

The question of altitude is greatly over emphasized. If a competitor is in good condition and in training it will make little difference in his performance. What it will do, however, is lengthen the time necessary, to recuperate after a bout. If one is not in top shape, of course the altitude will affect you a great deal. I believe strict control should be exercised over nutrition. Athletes should only eat at the U.S. restaurant or other place approved by our officials so as to cut down on digestive problems. I do not believe we need any special training other than the normal to compete in Mexico. This view apparently is not shared by some of the other nations. The Italians arrived 3 weeks early, the Russians trained at a camp located at

the same altitude as Mexico City since October 7 and after the Tournament were returning to that camp until October 27. They may have something, as they won 3 of the 4 events.

The Team

Last, but not least, I want to comment on our Team. It was small and composed of three men young in age and international experience. Jan of course was the veteran and a steady influence. The spirit was excellent and each tried to outdo the other in being helpful. Their conduct both on and off the strip brought credit to the U.S. For my part, I served on the Directorate Technique, directed, acted as an interpreter and had a busy and valuable experience.



Illinois

by Ella C. Hrabar

Sabre Open: 1. G. Soshovsky, CFC; 2. R. Tykodi, CFC; 3. J. de Lannoy, CFC

Epee Open: 1. D. von Oppen, CFC; 2. R. Green, CFC; 3. W. Harwood, CFC

Sabre Open: 1. R. Tykodi, CFC; 2. G. Sosnovsky, CFC; 3. D. Walker, CFC

Epee Open: 1. D. von Oppen, CFC; 2. E. Longstreet, CFC; 3. G. Sosnovsky, CFC

Open Sabre: 1. R. Tykodi, CFC; 2. J. de Lannoy, CFC; 3. D. von Oppen, CFC

Foil Open: 1. A. Zombolas, CFC; 2. M. Gilman, CFC; 3. D. von Oppen, CFC

Women's Open: 1. J. Lux, CFC; 2. M. Rudman, CFC; 3. S. Fain

Women: 1. C. Remenyik, CFC; 2. J. Lux, CFC; 3. C. Bond, Milwaukee

Foil: 1. A. Zombolas, CFC; 2. E. Zeisig, Milwaukee; 3. M. Gilman, CFC

Sabre: 1. W. Goering, Detroit; 2. R. Foxcroft, Canada; 3. W. Giovan, Detroit

Women: 1. C. Remenyik, CFC; 2. C. Bond, Milwaukee; 3. M. Rudman, CFC

Central Florida

by Karen Meadows

Sabre: 1. Rick Coll, Bankuti; 2. John Shinner, St. Pete FC; 3. Dean Morehouse, Tampa FC

Epee: 1. Rick Coll, Bankuti; 2. John Shinner, St. Pete FC; 3. Joe Williamson, Fla. Pres. Coll.

Long Island

by Alfred Bachner

Women's Open: 1. Abby, Lucia; 2. Melnick, N.J.; 3. Verrier, Conn.

Sabre Open: 1. Pongo, NYAC; 2. Alexander, LIS; 3. Gall, NYAC

Jones Beach - (15 teams, 60 individuals)

4 Weapon Team won by Washington, D.C. (Kadis, Smith, Lyons, Herzig)

Foil: 1. Kamhi, Santelli; 2. Johnes, Santelli; 3. Obst, Canada

Women: 1. O'Connor, Santelli; 2. Chatel, Canada; 3. Smith, Wash., D.C.

Epee: 1. Russell, Santelli; 2. Melcher, FC; 3. Charron, Canada

Sabre: 1. Schwende, Canada; 2. Milletari, FC; 3. Haskell, Detroit

Epee Open: 1. B. Melworm, Unatt.; 2. M. Benjamin, Bankuti; 3. J. Dixon, N.Y.U.



IMPORTED FROM GERMANY

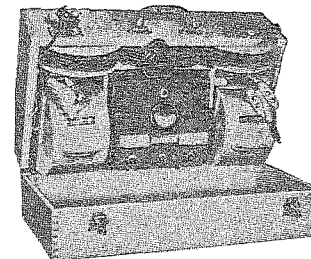

Fine quality, FIE approved
Combination Foil-Epee or Separate

HANS HALBERSTADT

3145 Fillmore Street
San Francisco 23, California

IN WASHINGTON, D.C.

fence at

DISTRICT OF COLUMBIA FENCERS CLUB

Over 53 years at

WASHINGTON Y.M.C.A.

736 G St. N.W.

NA 8-8250

AFLA Schedules

November

3	Met.	Sabre Open	NYAC	12:30 PM
	No. Calif.	Epee 'C'	PAC	1:30 PM
	No. Tex.	Boys' and Girls' Foil	Cistercian School	10 AM, 2 PM
4	Met.	Foil A/B	Fencers Club	11 AM
	New England	Foil Prep, Sabre Prep	Brandeis	1:30 PM
5	Met.	Epee Open,	NYAC	12:30 PM
	No. Calif.	Foil Introductory, men & women	Balboa HS	1:30 PM
	No. Ohio	Foil, Epee	Cleveland	
	No. Tex.	Women's Prep & Open; Foil Jr; Sabre Open	Dallas AC	10 AM
1	Oregon	Benefit Tournament	Portland	
	Met.	Women's Open	Fencers Club	11 AM
	No. Ohio	Women, Sabre	Cleveland	
	New Eng.	Sabre 'C', Epee Novice	MIT	1 PM

December

4	Met.	Sabre B	NYAC	12:30 PM
	No. Calif.	Foil Open	PAC	1:30 PM
	No. Tex.	Collegiate Tournament	U of Texas	
	Oregon	Epee Prep, Foil	Portland	10:30 AM
5	Met.	Foil Open	Fencers Club	11 AM
	New Eng.	Foil and Women's Open	Brandies	1:30 PM
	Oregon	Women	Portland	1 PM
1	No. Tex.	Women's Open & Novice; Foil Prep; Novice; Open	No. Tex. State	10 AM & 2 PM
	No. Calif.	Epee Open	PAC	1:30 PM
	West Point	Foil & Epee 'C'	USMA	1 PM
2	Met.	Epee 'B'	NYAC	12:30 PM
	West Point	Women's 'C'	Fencers Club,	11 AM
	New Eng.	Sabre 'C'	USMA	1 PM
	No. Calif.	Epee Open, Foil Unclass.	Boston Y	1 PM
7	No. Calif.	Sabre Open	LGH	8 PM
3	Met.	College Invitation	NYAC	12:30 PM
	No. Calif.	Women's Open	PAC	10 AM
3	Met.	Piller Sabre Invitation	NYAC	11 AM
	New Eng.	Sabre Open, Women's Novice	MIT	1 PM

January

1	No. Calif.	Piller Foil	PAC	10 AM
		Piller Sabre	PAC	3 PM
1	Met.	Women's Open	Fencers Club	11 AM
3	Met.	Sabre Open	NYAC	12:30 PM
	No. Calif.	Piller Epee	PAC	10 AM
		Piller Women	PAC	3 PM
1	Met.	Jr. Olympic	NYAC	12:30 PM
	No. Calif.	Women's 'B'	PAC	10 AM
1	No. Ohio	Cleveland International Tournament		
1	No. Ohio	Cleveland International Tournament		
1	Met.	Foil Open	Fencers Club	11 AM

International Schedules

November '65

1	Belgium	Epee Individual	Antwerp
1 - 22	Turkey	Foil and Epee	Ankara
1	France	Epee	Lyon

December '65

1 - 5	Austria	All weapons	Vienna
-------	---------	-------------	--------

January '66

3 - 9	France	Monal Epee	Paris
5 - 16	France	Martini Foil	Paris
2 - 23	England	Miller Hallet Epee	London

29 - 30 --- Italy --- Spreafico Epee --- Milan

February '66

3 - 6	Poland	All weapons	Vroczlaw
12 - 13	Belgium	Martini Sabre	Brussels
	France	Bonin Foil	Melun
		Picon Epee	Levallois
13	France	Roland Women's	Melun
18 - 20	USA	Martini & Rossi, NYAC International	New York
19 - 20	Italy	Epee Team	Milan
26 - 27	Belgium	Sabre, Epee, Women	Duren
	France	Duval Foil	Paris
27	France	Under 20 (4 weapon teams)	Cannes
	Hungary	Epee	Budapest

March '66

5 - 6	Belgium	Vierzet Epee	Huy
6	France	All weapons	Nice
6 - 9	Poland	Sabre	Poznan
11 - 13	Poland	Sabre Team and Ind. Invitation	Poznan
12	England	Martini Epee	London
12 - 13	France	Sabre	Montreuil
18 - 20	France	Foil Team & Ind.	Paris
19 - 20	France	Martel Epee	Poitiers
	Germany	Under 20 Foil Men and Women	Weinheim
26 - 27	Germany	Under 20 Teams (4 weapons)	Dortmund

April '66

2 - 3	Italy	Martini & Rossi Women's	Turnin
8 - 11	England	All weapons	London
9 - 10	Austria	Under 20 World Championships	Vienna
15 - 16	Germany	Epee Team	Heidenheim
23 - 24	Holland	All Weapons, Team & Ind.	Amsterdam
	Switzerland	Longines Epee	Berne
24	France	Sabre	Provence
29 - 30	Hungary	Sabre Team	Budapest
30 - 1	England	de Beaumont Women's	Budapest

May '66

1	Hungary	Sabre	London
1 - 2	Belgium	Epee Invitation	Brussels
7 - 8	France	Sabre	Paris
	Germany	Women	Goppingen
	Poland	Epee, Sabre	Krakow
12 - 15	Poland	All weapons	Warsaw
15	France	Epee	Cannes
19	France	Epee, Sabre	Les Andelys
21 - 22	England	Foil (Coronation Cup)	London
	France	Epee	Belfort
	Italy	Women	Como
28 - 29	Italy	Sabre	Padua

June '66

4 - 5	England	Corble Sabre	London
	Italy	Giovannini Foil	Bologne
5	Belgium	Epee, Women	Eupen
11 - 12	Holland	Epee, Sabre, Women	Noordwijk
12	Czechoslovakia	Foil	Prague
	France	Epee, Women	Marseille
19	France	Epee	Lyon

July '66

(Early)		1966 WORLD CHAMPIONSHIPS	Moscow
23 - 24	France	Epee	Vittel

August '66

4 - 13	Jamaica	British Commonwealth Games	Kingston
28	Luxembourg	Epee, Women	Mondorf-les-Bains

September '66		
1 - 4	— Hungary	— All Weapons
24 - 25	— Germany	— All Weapons
25 - 26	— Belgium	— Epee
		— Siogfok
		— Munich
		— Arlon
October '66		
1 - 2	— Germany	— Women's
8 - 9	— Germany	— Epee
9	— Poland	— Epee
15 - 16	— Germany	— Sabre
20 - 23	— Poland	— All Weapons
29 - 30	— Germany	— Under 20 Foil (men & women)
		— Cologne
		— Berlin
		— Warsaw
		— Hambourg
		— Katowice
		— Duisbourg
November '66		
13	— Germany	— Epee, Women
20	— Czechoslovakia	— Women
16 - 20	— Turkey	— Foil, Epee, Sabre
		— Sarrebruck
		— Olomoue
		— Ankara

